

SHARP

MX-M564N
MX-M464N
MX-M364N

Digital Multifunction System

Expandable Solution with Outstanding Eco Performance—
Your Ideal Partner in Growth



COPY

NETWORK PRINT

NETWORK
COLOUR SCAN

SHARPEDESK

FAX
OPTION

Catering to the Changing Needs of Growing Businesses

Any business in need of an energy-efficient partner that can keep pace with changing document demands should look no further than the configure-friendly MX-M564N/M464N/M364N.

Along with multifunction efficiency—including full-colour network scanning—this B/W A3 solution offers advanced environmental performance and easy expandability. Flexible system configurations allow the MX-M564N/M464N/M364N to accommodate nearly any type of business. There's a space-efficient inner finisher for workplaces with limited room, a 4,000-sheet finisher for offices handling high-volume jobs, and saddle stitch finishers for businesses requiring complex document finishing, like that needed for pamphlet making.

The MX-M564N/M464N/M364N also supports the Sharpdesk Mobile print/scan application for conducting business on the go and ensures the reliable safeguarding of business communications through built-in and add-on security functions.



Productive Performance

Already designed to maximize productivity, the MX-M564N/M464N/M364N becomes even more of a workhorse when the optional 500 + 2,000-sheet paper drawer is added on, boosting total paper capacity to 6,600 sheets. A variety of finishing options, including a 4,000-sheet finisher and two types of saddle stitch finishers, makes for attractive and efficient document finishing. And a 100-sheet RSPF (reversing single pass feeder) ensures the fast and smooth handling of one- or two-sided originals.



Eco Friendliness

The MX-M564N/M464N/M364N gets its eco edge from advanced environmental technologies incorporated throughout the MFP—from its hardware and electrical system down to its software and supplies. Even its short warm-up time of 12 seconds produces substantial energy savings.

The new Mycrostoner-CAP is one of those eco-boosting supplies. The low melting point of this proprietary toner lets it get the job done with less energy than conventional toner requires.

And this dramatically reduced power consumption is what gives the MX-M564N/M464N/M364N one of the lowest TEC values** in the industry—significantly lower than even the maximum values allowable under ENERGY STAR®.

Lower TEC Value

Model	TEC Value (%)	TEC Value (kWh)*3	Max. allowable TEC value*2
MX-M564N	54.8%	3.4 kWh*3	6.2 kWh
MX-M464N	59.5%	2.5 kWh*3	4.2 kWh
MX-M364N	64.5%	2.0 kWh*3	3.1 kWh

Shorter Warm-Up Time*4

12 seconds
40.0 %
down



*1 Typical amount of energy consumed in a hypothetical week measured as stipulated under the ENERGY STAR® programme.
*2 Maximum TEC value allowable under the latest ENERGY STAR programme (version 2.0).
*3 Measured at 230V.
*4 Compared to MX-M502N/M452N/M362N (warm-up time 20 seconds).



Ease of Use

The MX-M564N/M464N/M364N is equipped with a 7.0-inch WVGA touchscreen colour LCD that provides easy navigation of MFP functions and settings. The LCD also shows thumbnail displays and data file previews, raising the bar on user friendliness. A retractable QWERTY keyboard option offers added convenience.



Thumbnails*



Preview*

* Copy previews are in B/W.



COPYING & NETWORK PRINTING

PRODUCTIVE

Super-Efficient Output



The MX-M564N/M464N/M364N delivers a fast output of **56*1/46/36 cpm/ppm*2**. And the first copy comes out in just **3.7/3.9/4.5 seconds** to save valuable time when performing multiple short-run jobs.

*1: 51 cpm/ppm for MX-M564N when equipped with MX-FN10.
*2: A4 (8 1/2" x 11"), long-edge feeding

56 CPM PPM	46 CPM PPM	36 CPM PPM
MX-M564N	MX-M464N	MX-M364N

Built-In Duplex Module and RSPF



The MX-M564N/M464N/M364N can make **two-sided copies and printouts** using its built-in stackless duplex module, effectively reducing paper costs as well as saving filing space.

Duplex copying is even more effective when the duplex module is used together with the standard-equipped

100-sheet RSPF (reversing single pass feeder), which efficiently feeds in one- or two-sided originals and can also simultaneously scan paper of different sizes.



Job Build for Large-Volume Scanning



The MX-M564N/M464N/M364N easily handles large-volume copy jobs exceeding the RSPF's 100-sheet*1 capacity. For example, a 270-sheet original can be scanned as batches of 100 + 100 + 70 sheets and automatically stored on the MX-M564N/M464N/M364N's hard disk*2. Users can then print the entire document in a single run.

*1: A4 (8 1/2" x 11"), 80 g/m²

*2: The number of pages that can be stored for the Job Build function depends on the machine's HDD capacity and other conditions.

Extra Paper Capacity



For high-volume work, the MX-M564N/M464N/M364N can accommodate an optional **stand with 500 + 2,000-sheet paper drawer** for a total capacity of **6,600 sheets**. When a tray runs out of paper, the **Auto Tray Switching** function automatically switches to another paper tray filled with the same size paper, allowing you to do extra-large volume jobs without worry.



Long-Paper (Banner) Printing*



The optional **Long Paper Feeding Tray** accommodates extra-long paper up to **1,200 mm**—expanding the range of print products to include panoramic pictures, large display-window ads, banner signs, and more.



* Contact a Sharp customer representative for details on using this function.

(Image)

Professional-Looking Finishing



The MX-M564N/M464N/M364N offers plenty of finishing options to suit a variety of workplaces and applications. For basic sorting/stapling of documents of up to 50 sheets, two types of handy finishers are available: the **space-efficient Finisher** can be added on without taking up much room, while the **large-capacity Finisher** has output trays that can hold up to 4,000 sheets.

Saddle Stitch Finishers also come in two types: one has an output tray capacity of up to 1,000 sheets, while the other boasts a capacity of up to 4,000 sheets. In addition to basic sorting/stapling, both types of Saddle Stitch Finishers can fold/staple documents of up to 15 sheets to make completed booklets. **Punch Modules**, which punch holes in documents for easy filing, are available for each finisher.

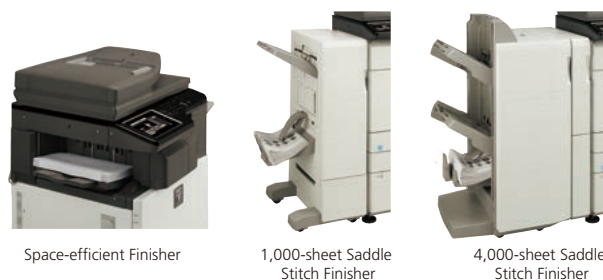

Space-efficient Finisher

1,000-sheet Saddle Stitch Finisher

4,000-sheet Saddle Stitch Finisher

Job Finishing Samples

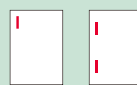

Stapling



Hole punching

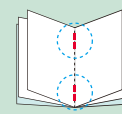

Saddle stitching

Network Tandem Function



When two MX-M564N/M464N/M364Ns are connected to the same office network, you can use both simultaneously to double copying/printing output to up to **112/92/72 cpm/ppm**.

Large-volume jobs can be completed with ease, enabling you to meet tight deadlines.

Supports Most Office Environments



- The MX-M564N/M464N/M364N works with the latest and most commonly used versions of Windows®, Windows Server®, and Mac operating systems and network protocols—including **IPv6**—even in mixed OS environments. You get fast, powerful network printing via the 1000Base-T **Gigabit Ethernet** standard.
- The MX-M564N/M464N/M364N supports the **PCL6** printer language. For compatibility with **PostScript® 3™**, the MX-PK11 PS3 Expansion Kit is available.

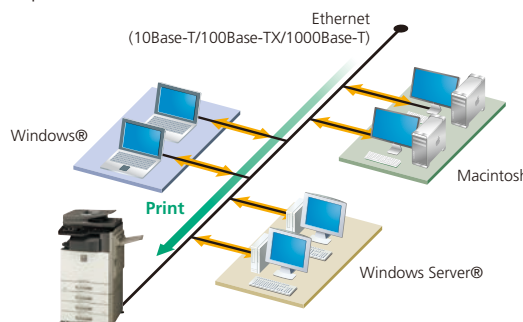

SUPERB IMAGE QUALITY

High-Resolution Output

The MX-M564N/M464N/M364N's digital smoothing technology enhances the 600-dpi print and copy resolution to the equivalent of **9,600 x 600 dpi** for incredibly smooth reproduction of fine lines. Fine-grained photographs, detailed illustrations and graphs, and small text come out crisp and clear.

Stable Halftones and Smooth Gradations

Halftone process control employs an image density sensor to enhance the stability and accuracy of halftones, thereby bringing consistently high image quality to copy/print jobs. Meanwhile, 4-bit depth, rated at 600 dpi resolution, generates fine dots and rich greyscales that provide smooth gradations.

Automatic Screen Frequency Selection

For enhanced image quality, the MX-M564N/M464N/M364N can automatically analyse the contents of each page and adjust the screen frequency (lines per inch) according to the most prominent element: text, photos, or graphics.

Enhanced Scan Performance

A function of Auto Colour Mode, the automatic suppression of unnecessary background colour is essential to achieving crisp, clear, natural-looking images. The MX-M564N/M464N/M364N provides enhanced background suppression without losing colour balance, resulting in scanned images that closely match the original.

Auto Colour Mode

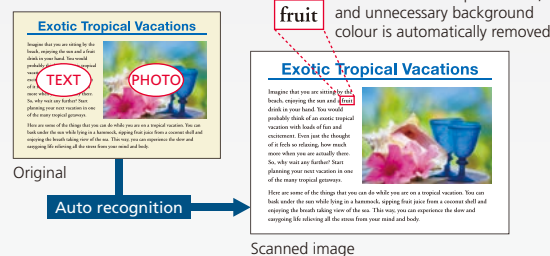

VERSATILE OPERATION

Direct Printing*

The MX-M564N/M464N/M364N can print PDF, TIFF, JPEG, XPS, and other files without using the printer driver. And there's a USB port beneath its control panel, which comes in handy when printing data directly from USB memory devices—an indispensable function for users who are in a hurry or who want quick machine access without a PC.

* Direct PDF printing requires optional MX-PK11, and direct XPS printing requires optional MX-PUX1 and 2GB of extra memory.



Versatile Paper Handling

The MX-M564N/M464N/M364N accommodates a wide range of paper sizes, from **A5 (5 1/2" x 8 1/2")** to **A3 wide (12" x 18")**. It can also handle heavy paper up to **300 g/m²** thick, further expanding the range of printing applications.

Image Editing Functions

The MX-M564N/M464N/M364N includes various editing functions made possible by digital technology.

- **Photo Repeat** places multiple copies of an image onto a single sheet.
- **Mirror Image** makes a reverse image of the original.
- **XY Zoom** adjusts the horizontal and vertical ratios independently.
- **B/W Reverse** reverses the black and white of an image.

Other Key Features

Copy & Print

- **Watermark** prints a user-selected watermark, such as "Urgent," on each page to indicate the status of the document.
- **Tab Copy / Tab Print** can copy or print directly onto tabs on document separators and insert them into assigned positions.
- **Multi-Shot** copying and **N-up** printing
- **Pamphlet Style** copying/printing
- **Multi-Page Enlargement** copying/printing
- **Cover/transparency** insertion

Print

- **Carbon Copy Print** mode automatically outputs multiple printouts of the same data on plain and/or coloured paper; convenient for invoices and purchase orders.
- **Form Overlay** can store office document formatting such as letterheads and overlay contents, eliminating the need for pre-printed paper. (PostScript driver only)
- **Barcode font compatibility***1

*1: Requires optional MX-PF10.

Copy

- **Book Copy** is convenient for compiling copies of a book or bound originals into pamphlet format.
- **Card Shot** enables one-touch copying of both sides of a card (credit cards, ID cards, etc.) onto a single page.
- **Stamp** labels your copies with page numbers, the date, or text such as "Urgent."
- **Mixed Size Original Copy** mode automatically distinguishes documents of mixed sizes*2 (such as A3/B4, B4/A4, etc.) fed through the RSPF and chooses the appropriate paper.

*2: Some restrictions apply when combining paper sizes of different format series.

IMAGE SENDING

Print Scan Fax

A3 Colour Network Scanning



The MX-M564N/M464N/M364N works as a **full-colour network scanner** and supports TIFF, PDF, PDF/A, encrypted PDF, JPEG, and XPS file formats. Converting any type of paper-based document, up to A3 (11" x 17") in size, into an editable digital file is as easy as making a copy. Enhanced scan performance improves the legibility of extremely fine text and allows vivid colour reproduction in scanned documents. And **Auto Colour Selection** chooses the right mode for scanning originals containing both colour and B/W pages.

Quick Scanning



For both colour*¹ and B/W documents, the MX-M564N/M464N/M364N carries out scanning at **56 opm*²** (originals per minute) and can complete large scan jobs with ease and efficiency.

*1: Faxing is available in B/W only. *2: Single-side scanning

Skip Blank Page Function



When printing* or scanning a multi-page document, the MX-M564N/M464N/M364N recognises and skips any pages without content, reducing both data size and transmission time and helping to save paper.

* Not including direct printing.

Multiple Distribution of Scanned Files



With the touch of a few on-screen buttons, you can choose different ways to distribute your scanned documents. **Scan to E-mail** sends documents as an e-mail attachment. **Scan to FTP Server** scans documents directly to an FTP server for storage. **Scan to Desktop** sends scanned documents directly to your PC desktop. **Scan to Network Folder (SMB)** sends files to a shared folder on a networked Windows PC. **Scan to USB Memory** scans documents directly to USB memory devices. And **Scan to Fax** enables conventional faxing or Internet faxing.

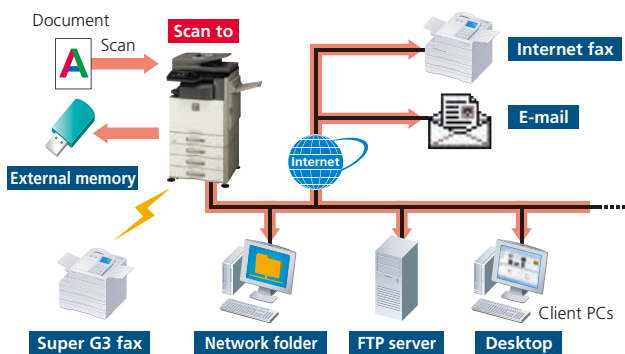

LDAP Support



Built-in LDAP (lightweight directory access protocol) support eliminates the need to enter or register full addresses. When you enter the first few letters of the recipient's name, the MFP displays a list of possible matches from your company's LDAP server. Selected addresses can be stored to the MFP's address book.



High-Speed Faxing



The optional MX-FX11 Fax Expansion Kit turns the MX-M564N/M464N/M364N into a 33.6 Kbps **Super G3 fax** machine. Quick On-Line Transmission initiates dialling and transmitting as soon as a page is scanned into memory. JBIG compression technology lets the MX-M564N/M464N/M364N send an A4 (8 1/2" x 11") size page in under three seconds*. And using the 100-sheet RSPF gives faxing efficiency a further boost. Incoming faxes are also handled with automated ease. The number of copies to be made can be specified on the LCD control panel's Fax Output setting, and optional finishing options can be installed for automatic stapling of those copies.

* Based on Sharp's standard chart with approximately 700 characters (A4 or 8 1/2" x 11" long-edge feeding) at standard resolution.

PC-Fax/PC-Internet Fax



Directly send a document created on your PC to a recipient's fax machine via a phone line or the Internet without printing to paper. Save time and paper costs while retaining original document quality. Note: PC-Internet Fax requires optional MX-FWX1; PC-Fax requires MX-FX11.

Internet Fax



Economically send and receive faxes to and from other ITU-T T-37-compliant Internet fax machines via the Internet. The MX-M564N/M464N/M364N supports **Direct SMTP**; outgoing Internet faxes do not go through your mail server, making transmission faster and cheaper.

Note: Requires optional MX-FWX1.

Paperless Faxing with Inbound Routing



Paperless faxing with inbound routing lets you check incoming faxes via e-mail before printing. It can also forward incoming faxes to another fax/Internet fax machine, an FTP server, a network folder (SMB), or a PC desktop. Files can be saved in either PDF or TIFF (single/multi).

Other Key Features

Scan & Fax

- **One-touch auto dial keys** register up to **1,000** numbers for frequently used destinations
- **Broadcast transmission** to up to 500 destinations
- **Program keys** (up to 48 keys) are available to set up frequently used transmissions for instant recall
- **Easy text entry*** lets you enter addresses, file names, subject titles or messages from the LCD control panel
* Only addresses can be entered for faxing.
- **Mixed size original scanning** automatically distinguishes documents of mixed sizes fed through the RSPF

Fax

- **Duplex transmission/reception** sends and prints out two-sided documents
- **SD memory card backup** ensures documents remain safely backed up in memory, even in the event of a power failure
- **Rotation transmission/reception** rotates incoming and outgoing faxes to match the direction of the printing paper
- **Fax destination confirmation** allows users to reconfirm fax numbers before sending to prevent transmission errors

DOCUMENT MANAGEMENT

Document Management on the Hard Disk

You can save processed job data in designated folders on the MX-M564N/M464N/M364N's built-in hard disk, making it easy to instantly recall saved documents or jobs for printing and sending at a later time. This contributes greatly to efficient sharing and distribution of information in your business operations.

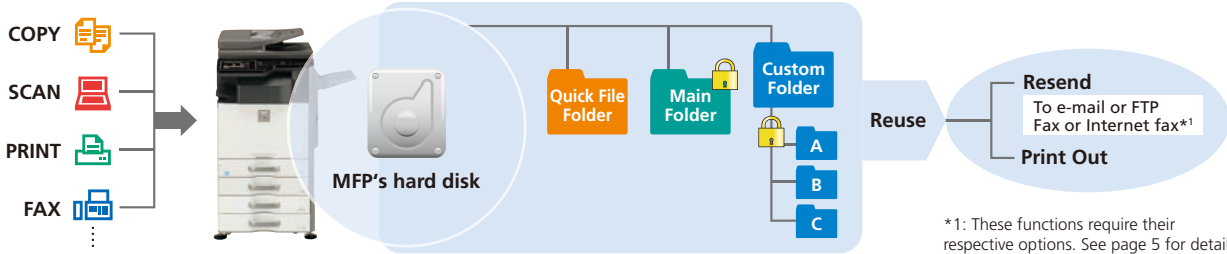

*1: These functions require their respective options. See page 5 for details.

Quick Filing

Up to **10,000 pages** or 1,000 files*² that have been copied, printed, scanned, or faxed*³ can be stored by job in a Quick File Folder. You can easily reuse saved data without having to reload or rescan the original.

Advanced Filing Function

Up to **20,000 pages** or 3,000 files*² that have been copied, printed, scanned, or faxed*³ can be stored by job on the hard disk in up to 1,000 folders with customised names and locations. Enhanced security features require users to enter a 5- to 8-digit password to access secure folders, protecting your sensitive data. Storage options include Main Folder for workgroup sharing and Custom Folder for enhanced-security archiving.

*2: Storage capacity will vary depending on the type of document and the scan settings.

*3: For fax and Internet fax jobs, only transmitted data (not received faxes) can be saved in the Document Filing function.

Easy Access to Stored Files

Documents stored on the hard disk can be quickly and easily searched and accessed from the control panel's LCD via thumbnail displays and file previews or through a Web browser.



Search results



Web access screen

Easy Sharing of Application Files

To facilitate file sharing across the office network, the MFP provides 120GB of hard disk storage space for folders. Each folder can hold up to 500 files created with applications such as Word and Excel® and saved in their original format.

Note: Sharp recommends backing up data saved to the MFP's hard disk.



Sharpdesk for Total Document Management

Sharpdesk is an original Sharp application that provides integrated desktop management of documents in over **200 file formats**, including scanned paper-based documents and those created with popular applications such as Word. It allows you to organise, edit, search, and distribute your documents, all with simple drag-and-drop operation.

- Intuitive desktop display features **thumbnail** viewing
- Sharpdesk Imaging provides **annotation** tools for paper-free proofreading
- Sharpdesk **Composer** combines different types of files into a single document
- **Optical character recognition** converts documents into editable text files
- **Output zone** distributes files to e-mail, printers, and other applications
- **File search** allows searching by file name, keyword, or thumbnail

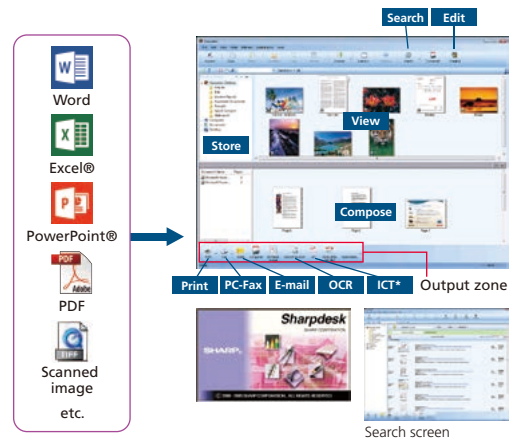

* Image Compression Tool for converting images into compact PDF files

Sharp OSA Network Scanner Tool

This client-based scan-to-desktop option is the ideal document management system for small workgroups or offices that don't have servers. Sharp OSA Network Scanner Tool provides centralised scan/print user profiles to give everyone in the office easy one-touch scanning to their PC from any networked MFP—without complicated settings. Scanned documents can be quickly and easily printed, filed, previewed, shared, and stored to save time and improve document workflow. And Sharp OSA Network Scanner Tool automatically names PDF files based on scanned-document titles and can convert scanned documents into text with the OCR engine to create searchable PDF files.

Note: Requires optional MX-AMX2.



SECURITY

Industry-Leading Multi-Layered Security

Designed to protect your business assets and bring you peace of mind, Sharp's industry-leading security solutions employ multiple levels of security functions—both standard equipped and optional—covering a broad range of network and data security needs. The MX-M564N/M464N/M364N safeguards sensitive data with powerful, enhanced security functions that eliminate the worry of unauthorised use and guarantee greater protection for your confidential information.

STANDARD

Secure Network Access

The **IP/MAC address filtering** function provides highly secure operation by restricting access to the MFPs on your office network. Only PCs that have either their IP address or MAC (media access control) address registered are allowed to use the MFPs. Attempted access from an unknown IP or MAC address will be denied, preventing unauthorised use. The MX-M564N/M464N/M364N also supports the **IEEE 802.1X** standard for port-based network access control, which blocks all access from unauthorised devices.

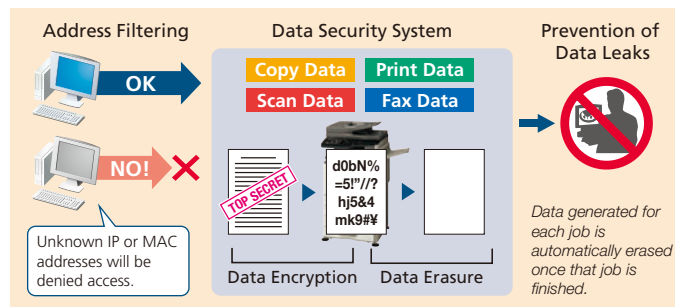

Data Encryption and Overwriting

Digital copier/printers and MFPs retain large amounts of data generated from copy/print/scan/fax jobs in internal storage. To safeguard confidential data from unauthorised access, standard-equipped security features on the MX-M564N/M464N/

M364N automatically **encrypt** job data prior to saving it to internal storage. Once a job is finished, that encrypted data is **erased** via up to seven automatic overwrites. **Protection** of administrator/file/folder passwords brings further peace of mind. Note: Contact a Sharp customer representative for details on activating these security functions.

User Authentication

The MX-M564N/M464N/M364N prevents unauthorised use by requiring **passwords** for machine access. This safeguarded solution can register up to 1,000 users in **three access levels** as Administrator, User, or Guest and can designate to which function user authentication applies. And the MX-M564N/M464N/M364N works with an **external Active Directory server** to extend user authentication to multiple MFPs and a greater number of users.



User authentication

IPv6 and IPsec Support

The MX-M564N/M464N/M364N supports the **IPv6** Internet protocol. An obligatory part of IPv6 is **IPsec** (IP Security), a set of protocols for securing Internet protocol (IP) communications. IPsec encrypts and authenticates traffic between specified parties, giving IPsec-compatible products an extremely high level of network security.

Data Initialisation

The MX-M564N/M464N/M364N's initialisation function allows confidential information to be erased at the administrator's discretion via the MFP's system setting. Initialising an MFP when it's time to replace it prevents important resources, such as customer information and intellectual property, from leaking out and provides considerable peace of mind.

Encrypted PDF with Password Protection

To prevent unauthorised viewing of confidential data, the MX-M564N/M464N/M364N enables scanned PDF data to be password protected and encrypted for transmission over the network. After transmission, viewers can gain access to the encrypted PDF only after re-entering the password.

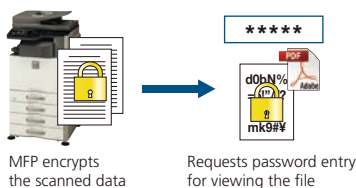

Secure Sockets Layer

SSL (secure sockets layer) enables the encryption of data communications to prevent data leakage through the network when printing via IPP, browsing secure Web pages (HTTPS), or communicating via e-mail (SMTP and POP3) or FTP (FTPS).

OPTION

Document Control Function

Document Control prevents unauthorised copying, scanning, faxing, and filing of confidential documents by embedding copy prevention data onto a document. When that data is detected, any unauthorised attempts to copy will be cancelled or will result in only blank-page output.

Note: Requires optional Data Security Kit. May not work for certain types of documents or paper.

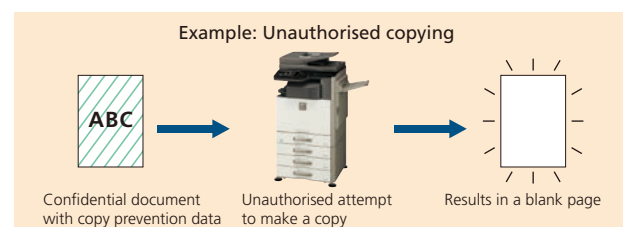



DEVICE MANAGEMENT

Web-Based System Settings

Administrators can manage every important setting—including user access and security as well as other controls and configurations—through a standard Web browser right from their desktops.

Remote Diagnosis

The MX-M564N/M464N/M364N can be monitored remotely through a Web browser, letting administrators handle tasks before they become problems. And when action or maintenance is required, the **E-Mail Status and Alert** function notifies administrators via timely e-mail alerts.

Network Utility Software

Sharp Remote Device Manager* (SRDM) gives administrators centralised control of their networked MFPs through a standard Web browser, making device cloning and other operations easier and more accessible.

* Contact a Sharp customer representative for availability and other details.

Remote Operation

The Remote Operation function lets you display the MFP's main control panel on your PC screen, allowing you to operate every major function directly from your desktop.* This function also enables the administrator to guide an MFP user through necessary procedures and allows remote MFP operation from a wheelchair.

* Requires VNC application.



EASE OF USE

7.0-Inch Touchscreen LCD

The MX-M564N/M464N/M364N's control panel features a wide, clear, WVGA-resolution touchscreen LCD. Easy-to-follow guidance puts step-by-step instructions on the LCD to guide you through all the necessary procedures for staple/sort finishing, pamphlet making, and other functions.



Thumbnail Display and Previews

Displaying thumbnails and up-close previews of Document Filing data files along with file names on the MX-M564N/M464N/M364N's LCD makes searching for files easy and convenient. It can also prevent errors by allowing users to confirm finishing options, scan settings, and other such items before copying, scanning, or saving documents to the MFP's hard disk. Thumbnails and previews of incoming faxes and Internet faxes can also be displayed on the LCD to help users decide which documents to print out or forward to others.



Saddle stitching (preview)



2-in-1 copying (preview)

Retractable Keyboard (option)

A **full-size retractable QWERTY keyboard** slides out from beneath the control panel to make text input fast and easy: convenient for typing things like e-mail addresses and messages, as well as passwords for user authentication.



Job Status Screen

Whether printing or copying, the control panel displays a list of all jobs, showing you at a glance the jobs in progress and the position of your job in the queue. And, with a few quick touches of the LCD screen, the **Priority Printing** function lets you easily **change the job queue order** or delete jobs that are no longer needed.



Job status

Easy-Grip Handles

Easy-grip handles on the MX-M564N/M464N/M364N reflect a universal design that allows the paper drawers to be grasped from the top as well as the bottom for easy opening and closing.

ENVIRONMENT-FRIENDLY

Outstanding Energy Efficiency

- Sharp's belt fusing system reduces energy consumption and as a result, shortens the MX-M564N/M464N/M364N's warm-up time to 12 seconds.
- Based on prior usage patterns, the MX-M564N/M464N/M364N automatically determines the optimal length of time to let elapse before going into **auto power shut-off mode**, helping reduce overall power consumption. And pressing the **power save key** after a job is finished immediately puts the MFP into auto power shut-off mode for further cutbacks on running costs.
- **Power ON/OFF Schedule** function automatically turns the MX-M564N/M464N/M364N on or off according to time schedules set by the administrator.

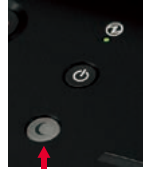

Power save key

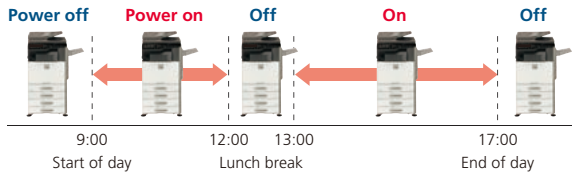

- Energy-efficient **LED lamps** employed in the scan unit (instead of conventional xenon lamps) provide further energy savings.
- **Eco Scan** function saves energy by keeping the fusing system shut down during jobs that don't require its use, such as Image Sending and Document Filing.

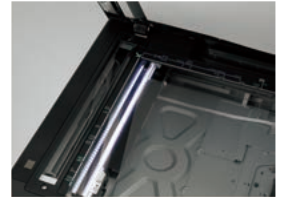

Eco-Friendly Supplies

- **Mycrostoner-CAP** toner particles are in capsule form, and each capsule is filled with low-melting-point material. That gives Mycrostoner-CAP a lower melting point than conventional toner and allows it to fuse at lower temperatures, resulting in reduced energy consumption and lower TEC values for the MFP.
- Longer-life supplies (drum unit, developer, service parts) contribute to resource savings.

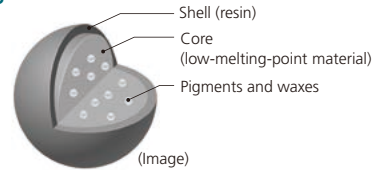

Mycrostoner-CAP

EXPANDABILITY

Sharp OSA* (Open Systems Architecture)

Innovative Sharp OSA technology allows you to interact with critical business and network applications right from the LCD control panel, offering a new realm of control and convenience. And since Sharp OSA utilizes industry-standard network protocols, the MX-M564N/M464N/M364N can easily integrate with document management systems, enterprise resource planning software, workflow applications, and more. The latest version of Sharp OSA can **reach beyond the firewall**, enabling extensive system construction and services over the Internet. Sharp OSA brings benefits such as reducing the costs associated with system implementation and management, as well as enabling data sharing across company branch offices or subsidiaries—effectively enhancing total business efficiency.

* Requires optional MX-AMX2 and/or MX-AMX3.

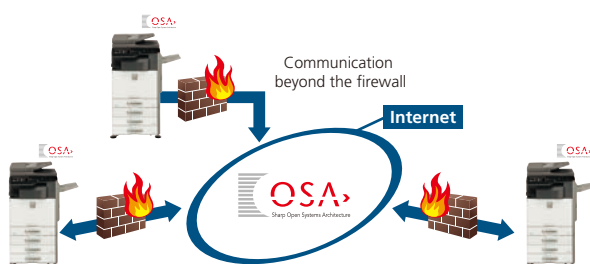

Sharpdesk Mobile*

Sharpdesk Mobile is a mobile print/scan application that combines the convenience of mobile devices and the efficiency of Sharp MFPs to make conducting business on the go easier than ever. Documents scanned on a Sharp MFP can be sent to a mobile device to preview and save. Documents saved on a mobile device can be printed out on the MFP, sent as e-mail attachments, or used in other applications.

* Availability varies by country/region. For details, see the Sharpdesk Mobile support Web site:
http://sharp-world.com/products/copier/docu_solutions/mobile/sharpdesk_mobile/

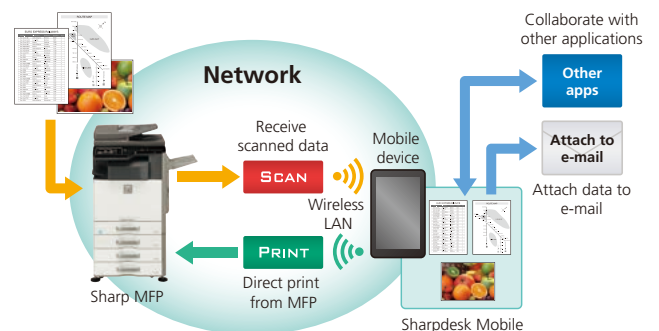



OPTIONS

System Configuration

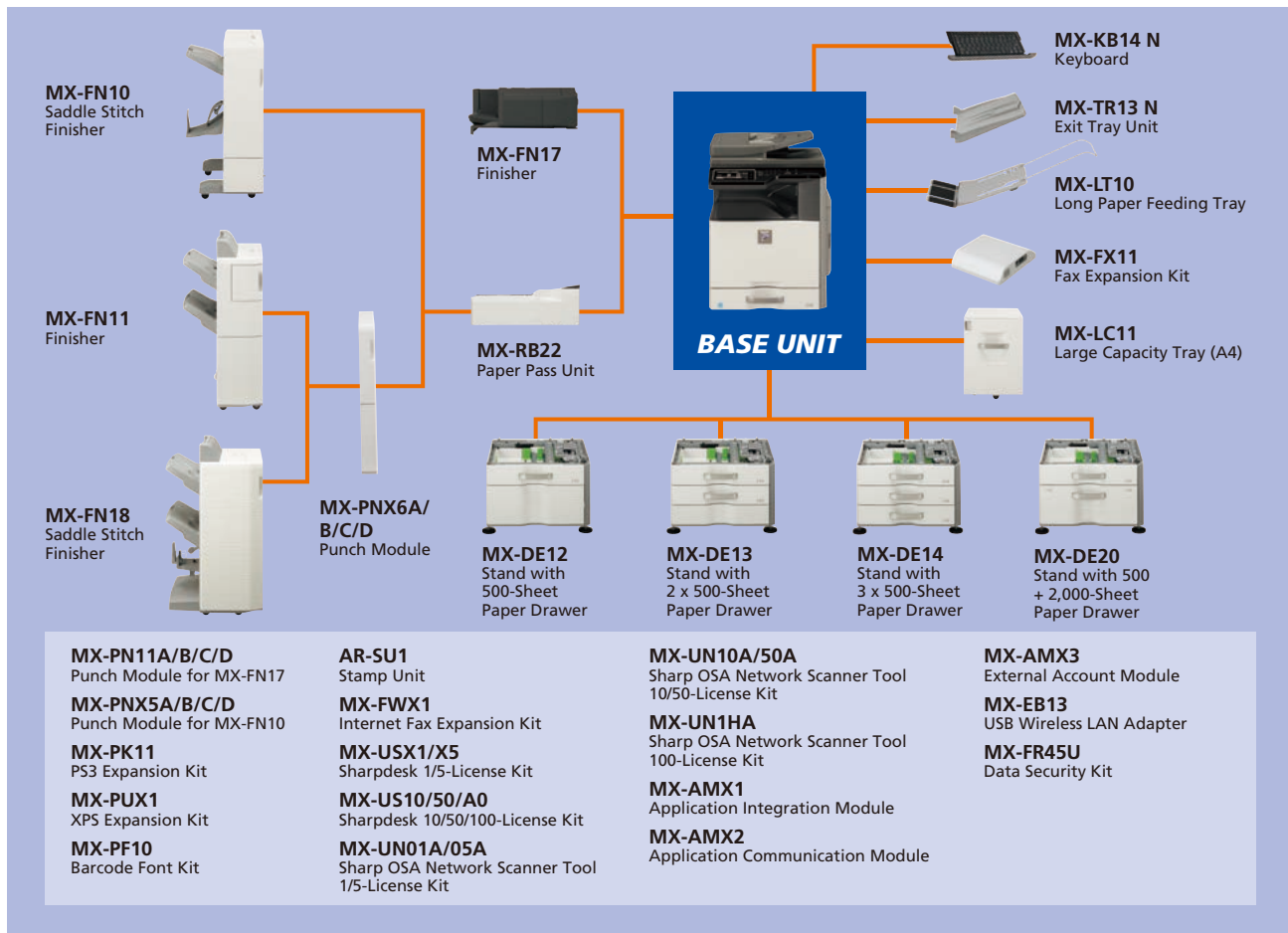

Certain options may not be available in some areas.

Specifications for Options

MX-FN17 Finisher

Paper size	Non offset Offset/staple	A3W (12" x 18") to A5 (5 1/2" x 8 1/2")*1 A3 (11" x 17") to B5*2 (8 1/2" x 11")
Max. paper capacity		500 sheets (A4 or smaller), 250 sheets (B4 or larger)
Max. stapling capacity		50 sheets (A4 or smaller), 30 sheets (B4 or larger)
Staple position		3 locations (front, rear or both)

MX-FN10 Saddle Stitch Finisher

Paper size	Non offset Offset/staple Saddle stitch	A3W (12" x 18") to A5 (5 1/2" x 8 1/2")*1 A3 (11" x 17") to B5 (8 1/2" x 11")
Max. paper capacity	Offset tray Saddle stitch tray	A3 (11" x 17"), B4 (8 1/2" x 14"), A4 (8 1/2" x 11")*3 1,000 sheets (A4 or smaller), 500 sheets (B4 or larger) 10 sets of 11–15 sheets, 15 sets of 6–10 sheets, 20 sets of 1–5 sheets
Max. stapling capacity		50 sheets (A4 or smaller), 25 sheets (B4 or larger)
Staple position		3 locations (front, rear or both)

MX-FN11 Finisher

Paper size	Non offset Offset/staple	A3W (12" x 18") to A5 (5 1/2" x 8 1/2")*1 A3 (11" x 17") to B5*2 (8 1/2" x 11")
Max. paper capacity	Upper tray Lower tray	1,550 sheets (A4, 8 1/2" x 11") 2,450 sheets (A4, 8 1/2" x 11")
Max. stapling capacity		50 sheets (A4 or smaller), 30 sheets (A4*4, B4 or larger)
Staple position		3 locations (front, rear or both)

MX-FN18 Saddle Stitch Finisher

Paper size	Non offset Offset/staple Saddle stitch	A3W (12" x 18") to A5 (5 1/2" x 8 1/2")*1 A3 (11" x 17") to B5*2 (8 1/2" x 11") A3 (11" x 17"), B4 (8 1/2" x 14"), A4 (8 1/2" x 11")*3
Max. paper capacity	Upper tray Lower tray Saddle stitch tray	1,550 sheets (A4, 8 1/2" x 11") 2,450 sheets (A4, 8 1/2" x 11") 10 sets of 11–15 sheets, 15 sets of 6–10 sheets, 25 sets of 1–5 sheets
Max. stapling capacity		50 sheets (A4 or smaller), 30 sheets (A4*4, B4 or larger)
Staple position		3 locations (front, rear or both)

Punch Modules

Model name	For the MX-FN17 For the MX-FN10 For the MX-FN11/FN18	MX-PN11A MX-PNX5A	MX-PN11B MX-PNX5B	MX-PN11C MX-PNX5C	MX-PN11D MX-PNX5D
Number of holes		2	3	4	4 (wide)
Paper weight		55 to 256 g/m ² *			

* Guaranteed punchable weight is 55 to 128 g/m².

MX-DE12 Stand with 500-Sheet Paper Drawer

Paper size	A3 (11" x 17") to A5 (5 1/2" x 8 1/2")*1
Paper capacity	500 sheets

MX-DE13 Stand with 2 x 500-Sheet Paper Drawer

Paper size (upper and lower tray)	A3 (11" x 17") to A5 (5 1/2" x 8 1/2")*1
Paper capacity (upper and lower tray)	500 sheets each

MX-DE14 Stand with 3 x 500-Sheet Paper Drawer

Paper size (upper/middle/lower tray)	A3 (11" x 17") to A5 (5 1/2" x 8 1/2")*1
Paper capacity (upper/middle/lower tray)	500 sheets each

MX-DE20 Stand with 500 + 2,000-Sheet Paper Drawer

Paper size (upper tray) (lower right/left tray)	A3 (11" x 17") to A5 (5 1/2" x 8 1/2")*1 A4 (8 1/2" x 11")
Paper capacity (upper tray) (lower right tray) (lower left tray)	500 sheets 850 sheets 1,150 sheets

MX-LT10 Long Paper Feeding Tray

Paper size	Max. 1,200 mm long
Paper capacity	1 sheet

MX-LC11 Large Capacity Tray

Paper size	A4 (8 1/2" x 11")
Paper capacity	3,500 sheets

*1: Only short-edge feeding can be used with A5 (5 1/2" x 8 1/2") paper.

*2: Only long-edge feeding can be used with B5 paper.

*3: Only short-edge feeding can be used with A4 (8 1/2" x 11") paper.

*4: Short-edge feeding.

Note: All specifications relating to paper capacity refer to 80 g/m² paper.

Note: When using Sharpdesk, Sharp OSA Network Scanner Tool, and Sharp OSA, please ask your Sharp representative about PC system requirements.

SPECIFICATIONS (tentative)

General

Type	Desktop	
Engine speed	Max. 56*/46/36 cpm/ppm (A4, 8 1/2" x 11", long-edge feeding)	
Paper size	Max. A3 wide (12" x 18")*2, min. A5 (5 1/2" x 8 1/2")*3	
Paper capacity (80 g/m ²)	Standard: 600 sheets (500-sheet tray and 100-sheet multi-bypass tray) Maximum: 6,600 sheets	
Paper weight**4	Tray: 60 g/m ² to 220 g/m ² (16 lbs bond to 80 lbs cover) Multi-bypass tray: 55 g/m ² to 300 g/m ² (13 lbs bond to 110 lbs cover)	
Warm-up time*5	12 sec.	
Memory	Standard: 3GB (copy/print shared)	320GB HDD*6
	Option: 2GB	
Power requirements	Rated local AC voltage ±10%, 50/60 Hz	
Power consumption (max.)	1.84 kW (220 to 240V), 1.44 kW (100 to 127V)	
Dimensions (W x D x H)	608 x 690 x 837 mm (23 15/16" x 27 11/64" x 32 61/64")	
Weight (approx.)	MX-M564N/M464N: 66 kg (145.5 lbs) MX-M364N: 65 kg (143.3 lbs)	

SOC : Intel Atom D525 1.8 GHz

Copier

Original paper size	Max. A3 (11" x 17")	
First copy time*7	3.7/3.9/4.5 sec.	
Continuous copy	Max. 999 copies	
Resolution	Scan: 600 x 600 dpi, 600 x 400 dpi, 600 x 300 dpi*8 Print: 600 x 600 dpi, 9,600 (equivalent) x 600 dpi	
Gradation	Scan: 256 levels	Print: 2 levels
Zoom range	25% to 400% (25% to 200% using RSPF) in 1% increments	
Preset copy ratios	Metric: 10 ratios (5R/5E), inch: 8 ratios (4R/4E)	

DOC. FEEDER ORIGINAL WEIGHT"50-128g/m2

Network Colour Scanner

Scan method	Push scan (via control panel), pull scan (TWAIN-compliant application)	
Resolution	Push scan: 100, 200, 300, 400, 600 dpi Pull scan: 75, 100, 150, 200, 300, 400, 600 dpi 50 to 9,600 dpi via user setting	
File formats	TIFF, PDF, PDF/A, encrypted PDF, JPEG*9, XPS	
Scanner utility	Sharpdesk	
Scan destinations	Scan to e-mail/desktop/FTP server/network folder (SMB)/ USB memory	

*1: 51 cpm/ppm for MX-M564N when equipped with MX-FN10.
 *2: A3 wide (12" x 18") paper must be fed through multi-bypass tray.
 *3: Only short-edge feeding can be used with A5 (5 1/2" x 8 1/2") paper.
 *4: Depending on usage conditions and type of paper, printing may not be executed correctly.
 *5: At rated voltage, 23°C (73.4°F). May vary depending on operating conditions and environment.
 *6: HDD capacity depends on procurement and sourcing status.
 *7: Long-edge feeding of A4 (8 1/2" x 11") sheets from paper tray, using document glass, MFP in fully ready condition. May vary depending on operating conditions and environment.
 *8: Not available when using RSPF.
 *9: Colour only.
 *10: Storage capacity will vary depending on the type of document and the scan settings.
 *11: Some features require option(s).
 *12: Optional MX-PK11 required for Mac OS and EtherTalk.
 *13: PostScript requires optional MX-PK11. XPS requires optional MX-PUX1 and 2GB memory.
 *14: Based on Sharp's standard chart with approx. 700 characters (A4 or 8 1/2" x 11" long-edge feeding) at standard resolution in Super G3 mode, 33,600 bps, JBIG compression.

Document Filing

Document filing capacity*10	Main and custom folders: 20,000 pages or 3,000 files
Stored jobs*11	Quick file folder: 10,000 pages or 1,000 files
Storage folders	Copy, print, scan, fax transmission
Confidential storage	Quick file folder, main folder, custom folder (max. 1,000 folders) Password protection

Network Printer

Resolution	600 x 600 dpi, 9,600 (equivalent) x 600 dpi
Interface	USB 2.0, 10Base-T/100Base-TX/1000Base-T
Supported OS*12	Windows Server® 2003, Windows Server® 2008, Windows Server® 2012, Windows® XP, Windows Vista®, Windows® 7, Windows® 8, Mac OS X 10.4, 10.5, 10.6, 10.7, 10.8, 10.9
Network protocols*12	TCP/IP (IPv4, IPv6), IPX/SPX (NetWare), EtherTalk (AppleTalk)
Printing protocols	LPR, Raw TCP (port 9100), POP3 (e-mail printing), HTTP, Novell Printserver application with NDS and Bindery, FTP for downloading print files, EtherTalk printing, IPP
PDL (emulation)	Standard: PCL 6 emulation Option*13: PostScript® 3™ emulation, XPS
Available fonts	80 fonts for PCL, 136 fonts for PostScript 3 emulation

Facsimile (optional MX-FX11 required)

Compression method	MH/MR/MMR/JBIG
Communication protocol	Super G3/G3
Transmission time	Less than 3 seconds*14
Modem speed	33,600 bps to 2,400 bps with automatic fallback
Transmission resolution	From Standard (203.2 x 97.8 dpi) to Ultra Fine (406.4 x 391 dpi)
Recording width	A3 to A5 (11" x 17" to 5 1/2" x 8 1/2")
Memory	1GB
Greyscale levels	Equivalent to 256 levels

• Design and specifications are subject to change without prior notice.
 • Mycrostoner-CAP is a trademark of Sharp Corporation. Windows, Windows Server, Windows Vista, Excel, and PowerPoint are registered trademarks of Microsoft Corporation in the US and/or other countries. Mac, Mac OS, EtherTalk, and AppleTalk are trademarks of Apple Inc., registered in the US and other countries. PCL is a registered trademark of Hewlett-Packard Company. PostScript and PostScript 3 are either registered trademarks or trademarks of Adobe Systems Incorporated in the US and/or other countries. All other brand names and product names may be trademarks or registered trademarks of their respective owners.
 • The ENERGY STAR logo is a certification mark and may only be used to certify products that have been determined to meet the ENERGY STAR programme requirements. ENERGY STAR is a US registered mark. The ENERGY STAR guidelines apply to products only in the US, the EU, Japan, Canada, Australia, New Zealand, and Taiwan.

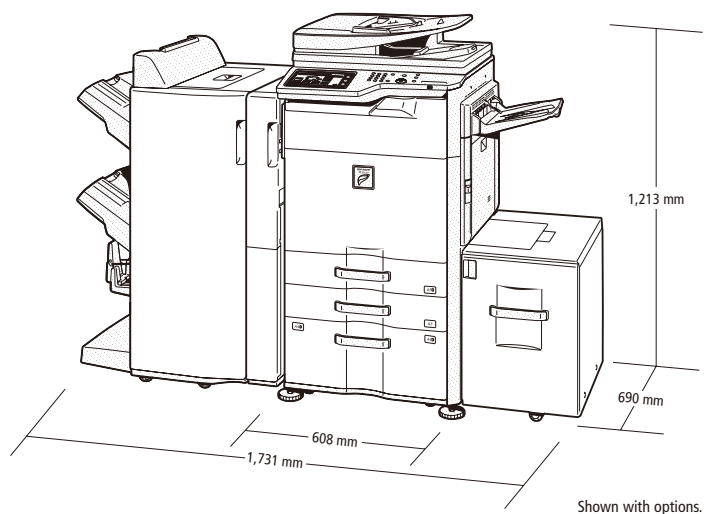

Distributed by:

